

1

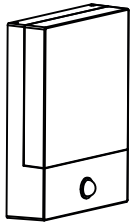

2

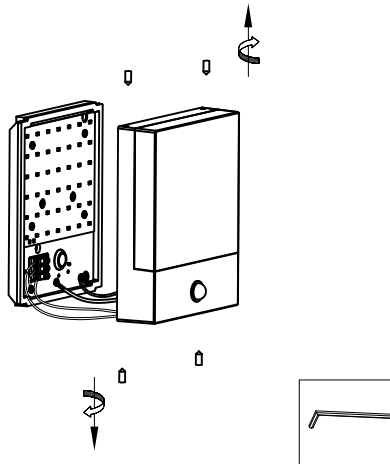

3

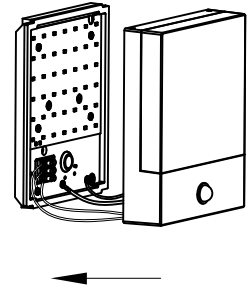

4

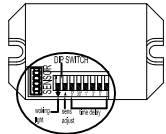
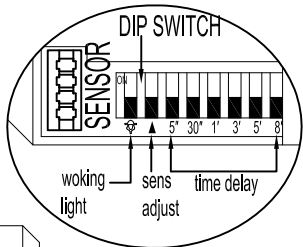

5

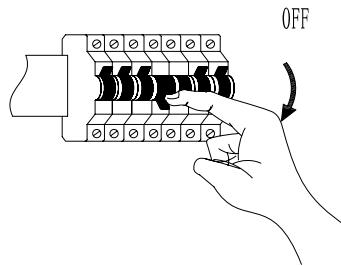

6

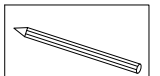
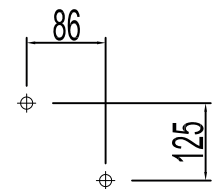

7

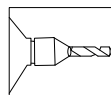
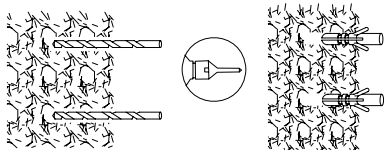

8

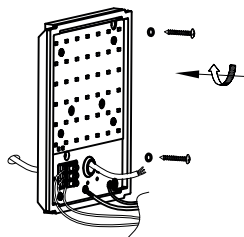

9

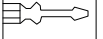
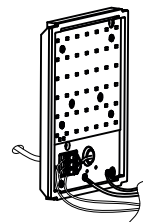

10

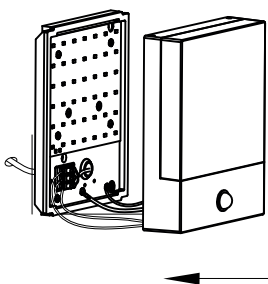

11

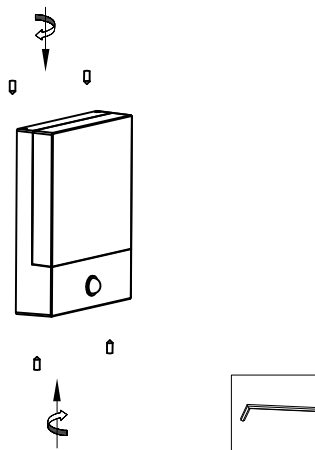

12

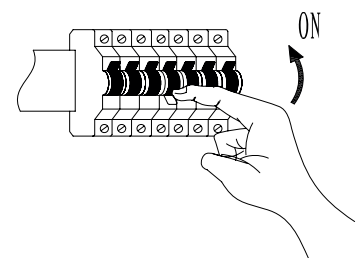

Infrared Sensor Instruction

This is an energy automatic sensor switch which can identify day and night. When an object enters the detecting range, the infrared detector switches on the lamp, after the object leaves the detection range, the lamp will turn off automatically.

Function :

1. Adopts 8-bit DIP switch:

- You can select working light to work only in the light below 10lux or in any light;
 - Adjustable sensitivity;
 - Choose working time-delay of the load: 5sec, 30sec, 1Min,3Min, 5Min, 8Min.
- 2.The time that the lights stays on can be set: it re-computes time after the last sensing;

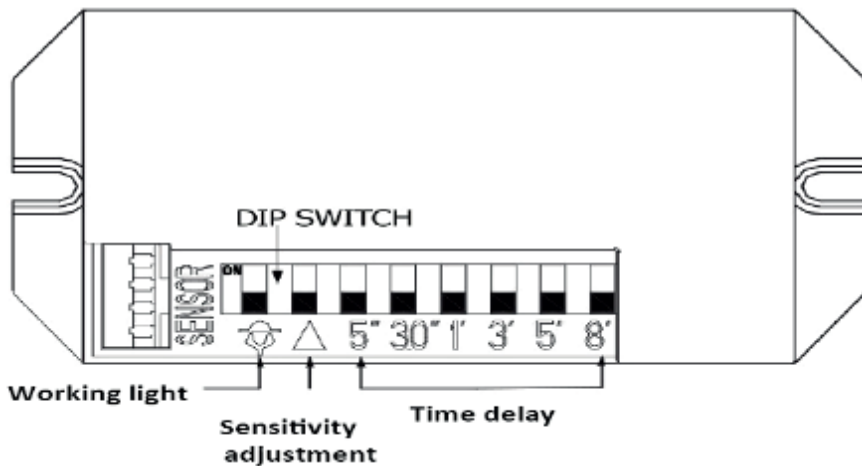

Dip switch setting

1. Working light (☉)selecting:

- when slide to OFF, the sensor is working also during the day time
- when slide to ON, the sensor works only at dark (<10LUX).

2. Sensitivity (△) selecting:

- when slide to OFF, High sensitivity;
- when slide to ON, Low sensitivity.

3. Time-delay (5sec, 30sec, 1min, 3min, 5min, 8min)

- when select a certain time-delay, you only slide that switch to the ON position.

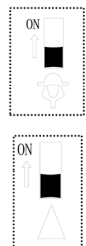

Attention

- The installing personnel should be electrician or with correlation experience;
- In front of sense range there should be no obstruction or moving object to influent its detecting.